

Inhalt Contents Contenu

Inhoud Contenido Conteúdo

Einzelteilübersicht / Spare parts list / Liste des pièces détachées / Onderdelenoverzicht / Lista da peças / Resumo de peça individual

3

Montagehilfen und Hinweise / Assembly aids and instructions / Aides de montage et instructions /
Montagehulpmiddelen en aanwijzingen / Ayudas de montaje e instrucciones / Montagens e indicações

5

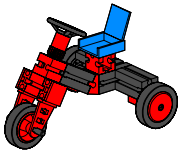

Dreirad / Tricycle / Tricycle /
Driewieler / Triciclo / Triciclo

6

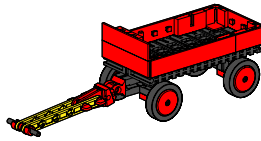

Handwagen / Hand cart / Voiture à bras /
Handkar / Carro manual / Carreta manual

8

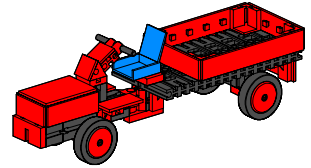

Einachstraktor / Single-axle tractor /
Tracteur à deux roues / Een-assige tractor /
Tractor de un solo eje / Trator de um eixo

10

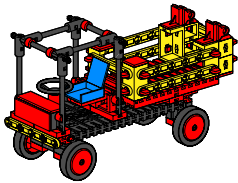

Heuwagen / Hay wagon / Chariot à foin / Hooiwagen /
Camión para la paja / Carro para feno

13

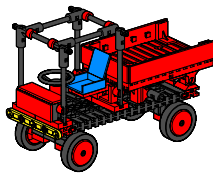

Lastwagen / Lorry / Camion /
Vrachtauto / Camión de carga / Caminhão

17

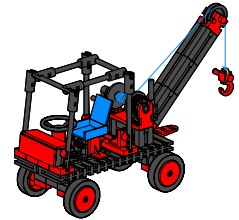

Abschleppwagen / Tow-car / Dépanneuse /
Kraanwagen / Grúa de remolcar / Carro rebocador

21

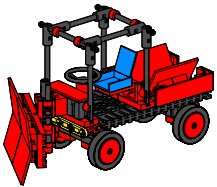

Schneepflug / Snowplow / Chasse-neige /
Sneeuwploeg / Quitanieves / Limpa-neves

24

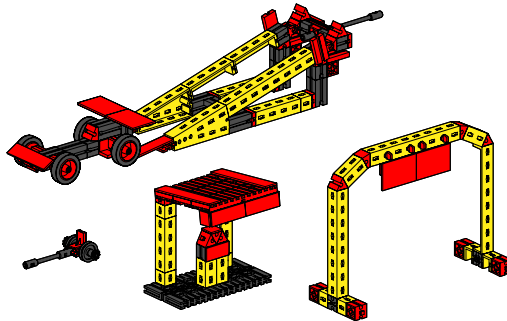

Racing

28

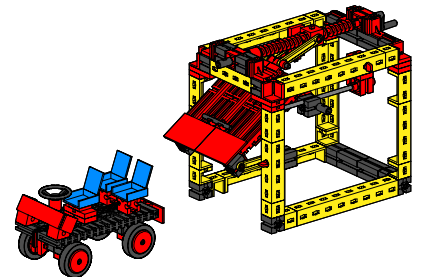

Garage mit Auto / Garage with car /
Garage avec Auto / Garage met auto /
Garaje con coche / Garagem com automóvel

37

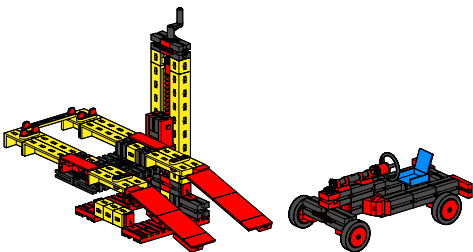

Hebebühne mit Auto / Lifting platform with car /
Pont élévateur avec voiture / Hefbrug met auto /
Plataforma elevadora con coche /
Plataforma elevadora com automóvel

46

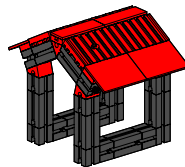

Haus / House / Maison / Huis / Casa / Casa

54



Turm / Antenna Tower / Tour /
Toren / Torre / Torre

56

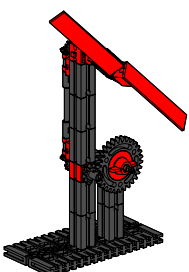

Ventilator / Fan / Ventilateur /
Ventilator / Ventilador / Ventilador

62

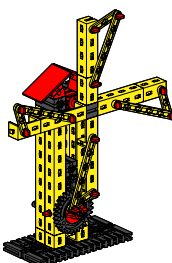

Windmühle / Wind mill / Moulin à vent /
Windmolen / Molino de viento / Moinho de vento

66

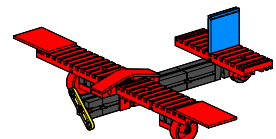

Flugzeug / Airplane / Avion /
Vliegtuig / Avión / Avião

71

Inhalt
Contents
Contenu

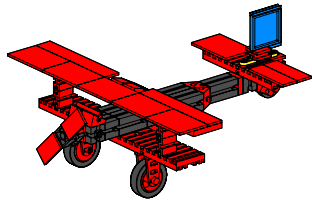

Doppeldecker / Double-decker / Biplan / Dubbeldekker /
Avioneta de doble ala / Avião de duas asas 73

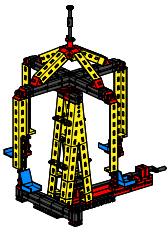

Großes Karussell / Big carousel /
Grand carrousel / Grote draaimolen /
Tio vivo grande / Carrocel grande 94

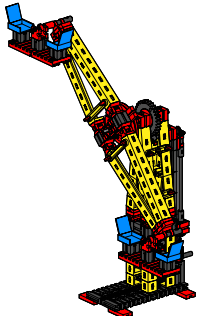

Drehschaukel / Rotating swing /
Balancoire rotative / Draaischommel /
Columpio giratorio / Balanco giratório 113

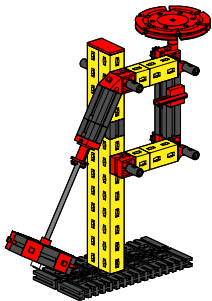

Briefwaage / Postal Scale / Pèse-lettres /
Briefweger / Balanza postal / Balança para cartas 128

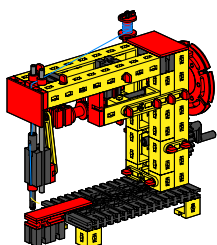

Nähmaschine / Sewing Machine /
Machine à coudre / Naaimachine /
Maquina de coser / Máquina de costura 141

Inhoud
Contenido
Conteúdo

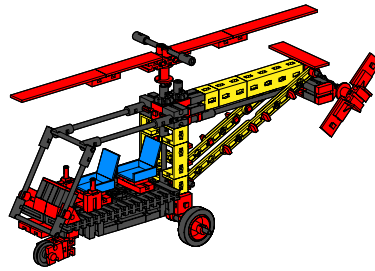

Helicopter 77

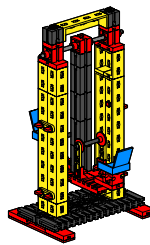

Große Schaukel / Big swing /
Grande balançoire / Grote schommel /
Columpio grande / Balanço grande 103

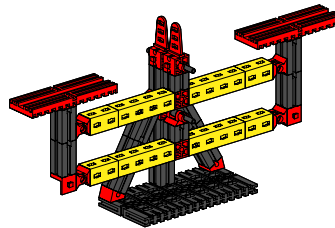

Balkenwaage / Balance Beam Scale /
Balance romaine / Balans met hefboom /
Balanza de barras / Balança de travessão 121

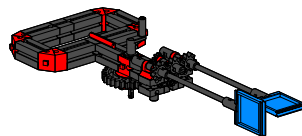

Quirl / Hand Blender / Fouet /
Garde / Batidora / Batedor 132

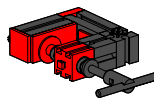

Schraubzwinde / Clamp / Serre-joint /
Lijmtang / Gato / Sargento de aparafusamento 148

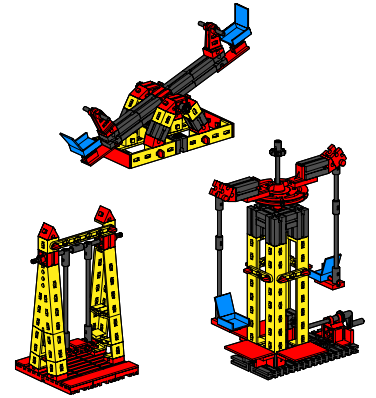

Spielplatz / Playground / Aire de jeux /
Speelterrain / Cancha de juego /
Parque de brinquedos 83

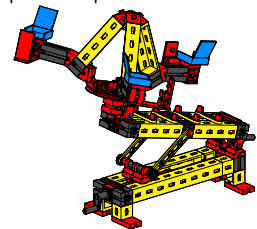

Zentrifuge / Centrifuge Ride / Centrifuge /
Centrifuge / Centrifuga / Centrifuga 107

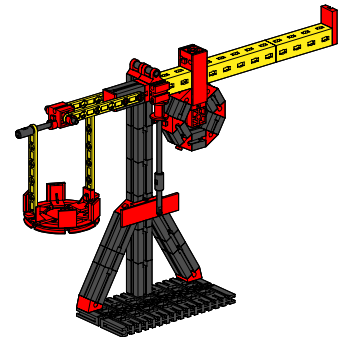

Waage mit Laufgewicht / Scale with sliding weight /
Balance à curseur / Balans met schuifgewicht / Balanza
con peso corredizo / Balança com peso móvel 124

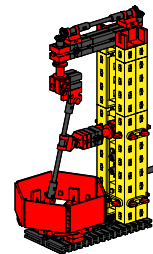

Küchenmaschine / Food Processor /
Robot ménager / Keukenmachine /
Aparato de cocina / Batedeira de cozinha 134

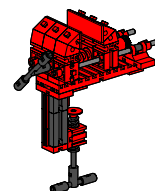

Schraubstock / Vise / Etou / Bankschroef /
Tornillo de banco / Torno de bancada 149

Inhalt
Contents
Contenu

Inhoud
Contenido
Conteúdo

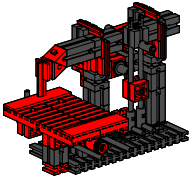

Hobelmaschine / Planer / Raboteuse /
Schaafmachine / Máquina afeitadora /
Máquina aplainadora 152

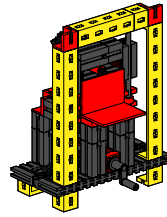

Stanze / Stamping press / Presse à estamper /
Stempelpers / Portapunzón / Estampadora 157

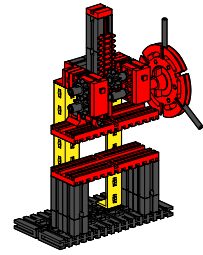

Presse / Rack Gear Press / Presse /
Pers / Prensa / Prensa 161

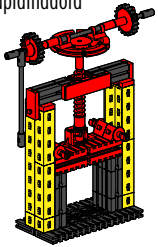

Spindelpresse / Screw Press / Presse à vis /
Schroefpers / Prensa de husillo / Prensa de fuso 165

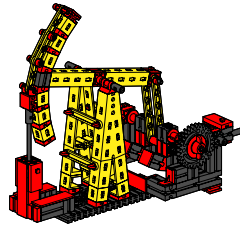

Ölpumpe / Oil Drill / Pompe à huile /
Oliepomp / Bomba de aceite / Bomba de óleo 169

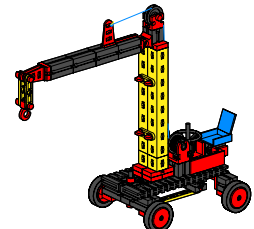

Werkstattkran / Shop Crane /
Grue d'atelier / Werkplaatskraan /
Grúa de taller / Guindaste de oficina 175

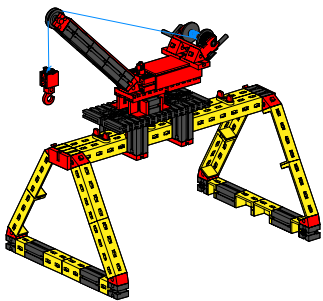

Portalkran / Gantry crane /
Grue à portique / Portaalkraan /
Grúa de portal / Guindaste de portal 179

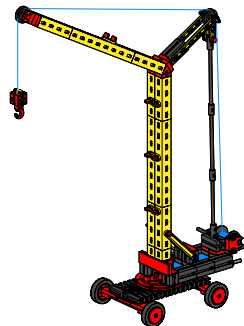

Baukran / Construction Crane / Grue de chantier /
Bouwkraan / Grúa de obra / Guindaste de obras 184

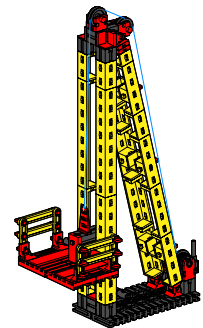

Materialaufzug / Material lift / Monte-charge /
Materialen hijstuig / Montacargas /
Elevador para material 193

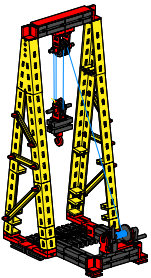



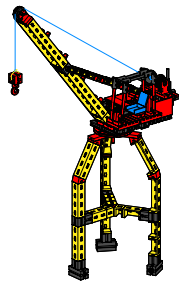





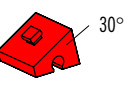
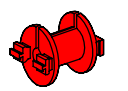
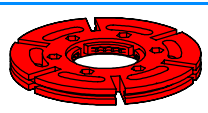

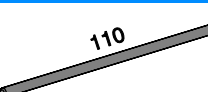
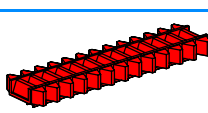
Flaschenzug / Block and Tackle Hoist / Palan /
Takel / Polipasto / Talha 198

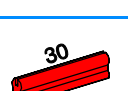
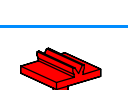
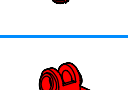
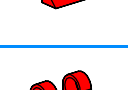
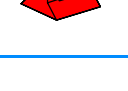
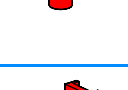



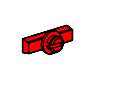
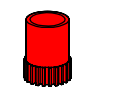
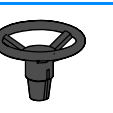
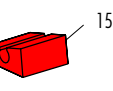

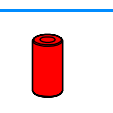
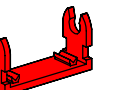

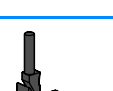
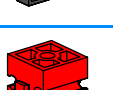
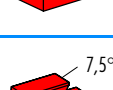
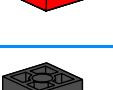
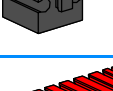
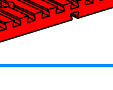

Hafenkran / Port crane / Grue de port /
Havenkraan / Grúa de puerto /
Guindaste portuário 204

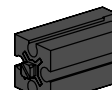
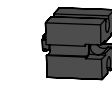
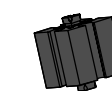

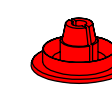
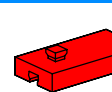
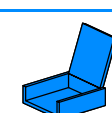
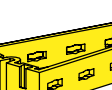

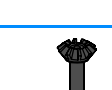
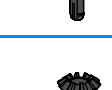

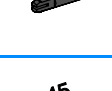
Einzelteilübersicht
Spare parts list
Liste des pièces détachées





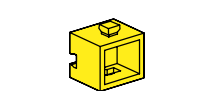
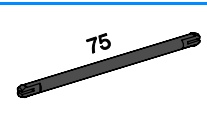

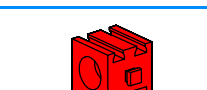
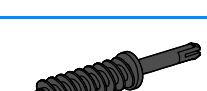
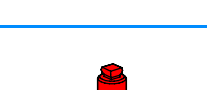
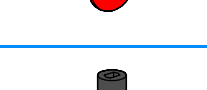
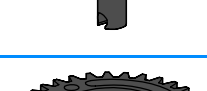



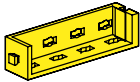





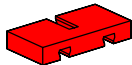

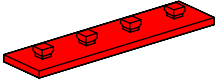

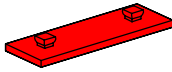

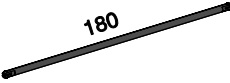
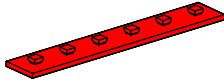
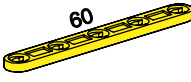

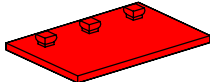
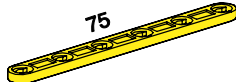
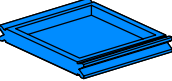
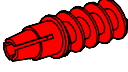

	31 010 8 x
	31 011 6 x
	31 016 2 x
	31 019 1 x
	31 021 2 x
	31 031 2 x
	31 053 1 x
	31 058 3 x
	31 060 7 x
	31 061 5 x
	31 124 1 x
	31 426 5 x
	31 436 9 x
	31 597 4 x
	31 674 4 x

	31 690 4 x
	31 848 6 x
	31 915 2 x
	31 916 1 x
	31 981 2 x
	31 982 9 x
	31 983 5 x
	31 997 1 x
	31 998 1 x
	31 999 1 x
	32 064 10 x
	32 071 8 x
	32 321 1 x
	32 859 3 x
	32 869 1 x

Onderdelenoverzicht
Lista da piezas
Resumo de peça individual

	32 879 11 x
	32 881 14 x
	32 882 6 x
	34 995 4 x
	35 031 3 x
	35 049 6 x
	35 051 4 x
	35 052 2 x
	35 053 6 x
	35 058 2 x
	35 061 4 x
	35 062 2 x
	35 063 3 x
	35 064 3 x
	35 065 4 x

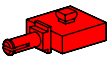
	35 066 3 x
	35 073 6 x
	35 076 6 x
	35 087 3 x
	35 088 2 x
	35 129 1 x
	35 797 3 x
	35 945 4 x
	35 973 1 x
	35 977 1 x
	35 980 4 x
	35 981 4 x
	36 227 8 x
	36 264 1 x
	36 294 4 x

	36 297 8 x		36 819 7 x		38 225 1 x		38 423 6 x
	36 298 6 x		37 237 8 x		38 240 6 x		38 428 4 x
	36 299 4 x		37 238 4 x		38 241 3 x		38 464 3 x
	36 323 24 x		37 468 6 x		38 242 4 x		38 538 4 x
	36 326 2 x		37 527 1 x		38 245 2 x		38 540 2 x
	36 328 4 x		37 636 2 x		38 246 6 x		38 544 4 x
	36 334 3 x		37 679 10 x		38 248 6 x		38 545 4 x
	36 341 2 x		37 858 1 x		38 260 4 x		78 237 1 x
	36 581 4 x		37 925 1 x		38 414 4 x		
	36 586 4 x		37 926 3 x		38 416 3 x		

- Alle Einzelteile, insbesondere bewegliche Teile sind falls notwendig zu warten und zu reinigen.
- All components, especially moving parts, should be maintained and cleaned as necessary.
- Toutes les pièces détachées et en particulier les pièces mobiles, sont, si nécessaire, à entretenir et à nettoyer.

- Achtung
Verletzungsgefahr an Bauteilen mit funktionsbedingten scharfen Kanten und Spitzen!
- Caution
Be careful not to hurt yourself on components with sharp or pointed edges!
- Attention
Risque de blessure sur les éléments comportant des arêtes et o pointes vives indispensables au bon fonctionnement!

- Alle onderdelen, vooral de bewegende delen, kunnen, indien noodzakelijk, onderhouden en gereinigd worden.
- Es necesario limpiar y mantener en buen estado todas las diferentes piezas - especialmente las piezas móviles.
- Caso necessário, todas as peças individuais, especialmente peças móveis, tem que ser submetidas à manutenção e ser limpidas.

- Let op
U kunt zich bezeren aan bouwstenen met scherpe randen of punten!
- Attenzione
Esiste il pericolo di lesione con i pezzi di costruzione che hanno bordi e punte spigolosi necessari per la funzionalità del pezzo!
- Atenção
Perigo de ferimentos em peças componentes com cantos vivos e pontas obrigatórias para o funcionamento !