

**Inhalt**  
**Contents**  
**Contenu**

**Inhoud**  
**Contenido**  
**Conteúdo**

Einzelteilübersicht / Spare parts list / Liste des pièces détachées / Onderdelenoverzicht / Lista da peças / Resumo de peça individual 2

Montagehilfen und Hinweise / Assembly aids and instructions / Aides de montage et instructions /  
Montagehulpmiddelen en aanwijzingen / Ayudas de montaje e instrucciones / Montagens e indicações 3

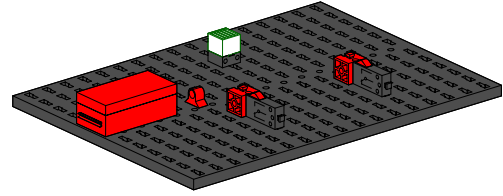
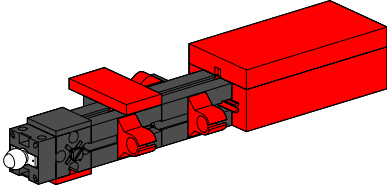

Taschenlampe / Torch / Lampe de poche /  
Zaklamp / Linterna / Lâmpada de mão 5

UND-/ ODER-Schaltung / AND-OR circuit / Circuit ET/OU /  
EN/OF-schakeling / Circuito Y/O / Conexão E/OU 11

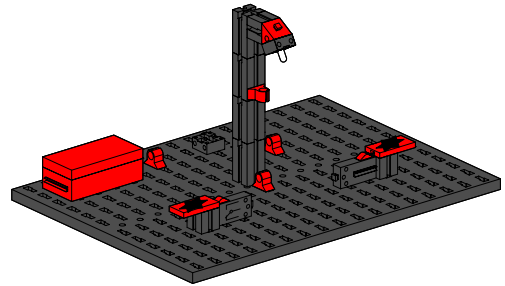
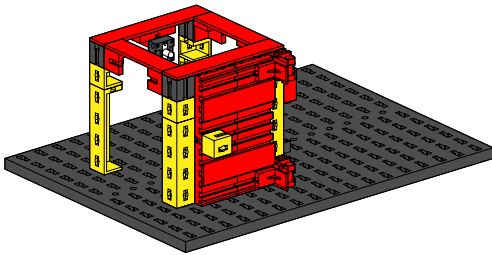

Kühlschrankbeleuchtung / Refrigerator with interior lighting / Réfrigérateur  
avec éclairage intérieur / Koelkast met binnenverlichting / Frigorífico con  
iluminación interior / Frigorífico com iluminação interior 6

Treppenhausbeleuchtung / Staircase lighting / Éclairage de cage  
d'escalier / Trappenhuisverlichting / Iluminación de escalera /  
Iluminação do vão das escadas 12

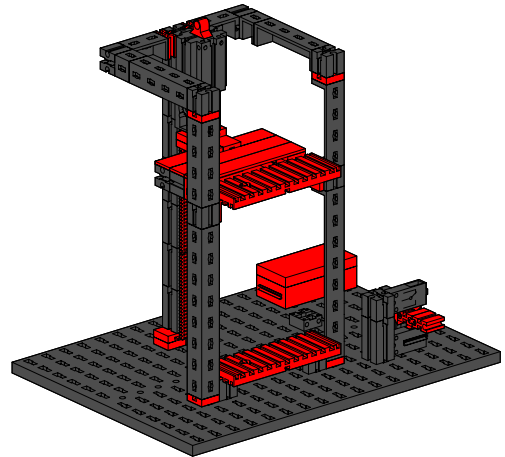
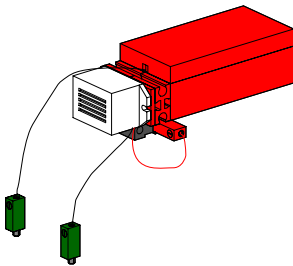

Durchgangsprüfer / Continuity tester /  
Appareil de contrôle de continuité / Doorgangstester /  
Probador de continuidad / Verificador de continuidade 9

Aufzug / Elevator / Ascenseur / Lift / Ascensor / Elevador 14

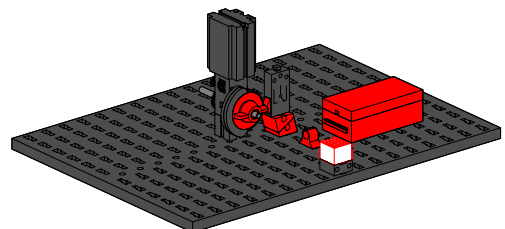
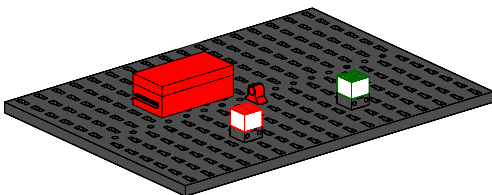

Reihen- und Parallelschaltung / Series and parallel connection /  
Circuit en série et en parallèle / Serie- en parallelschakeling /  
Conexión en serie y en paralelo / Conexão em série e paralela 10

Einfaches Blinklicht / Simple flash light / Feu clignotant simple  
Eenvoudig knipperlicht / Luz intermitente sencilla /  
Lâmpada intermitente 19

**Inhalt**  
**Contents**  
**Contenu**

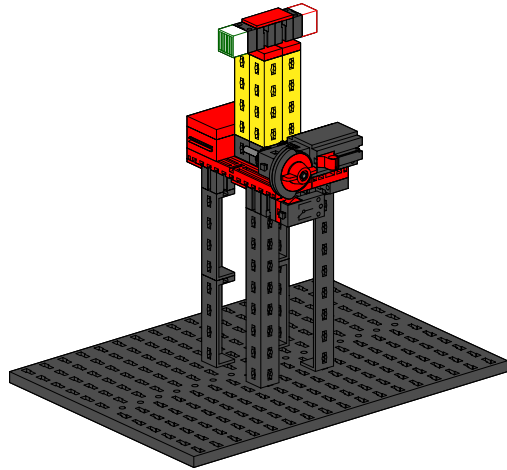

Turm mit Warnblinklicht / Tower with blinking warning light /  
Tour avec feux de détresse / Toren met knipperlicht / Columna  
con luz de aviso de emergencia / Torre com luz de aviso

20

**Inhoud**  
**Contenido**  
**Conteúdo**

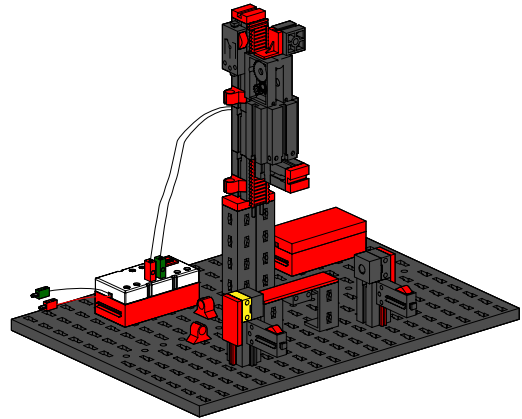

Stanzmaschine / Punching machine / Poinçonneuse /  
Stansmaschine / Punzonadora / Máquina de puncionar

34

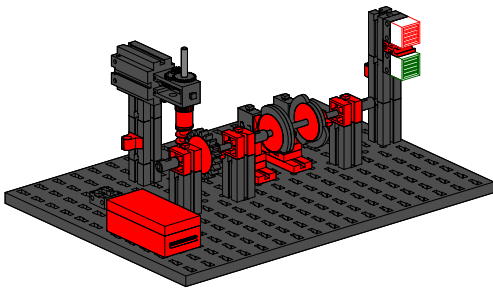

Ampelsteuerung / Traffic light control / Commande des feux de  
signalisation / Regeling van een verkeerslicht / Mando del semáforo /  
Comando de semáforo

24

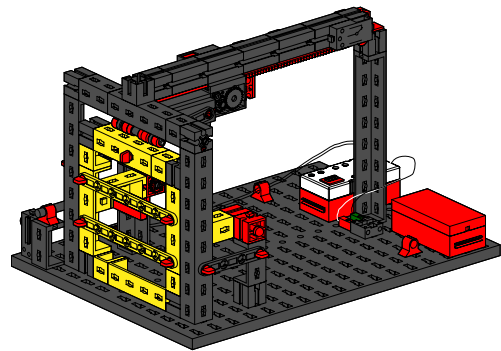

Garagentor / Garage door / Porte de garage / Garagedeur /  
Puerta del garaje / Portão da garagem

38

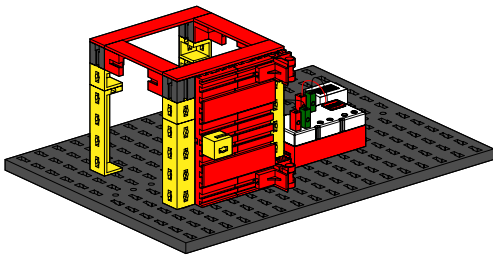

Alarmanlage / Alarm system / Dispositif d'alarme /  
Alarminstallatie / Instalación de alarma / Sistema de alarma

28

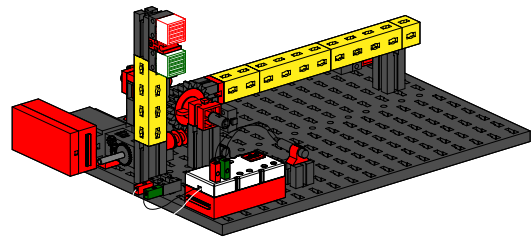

Parkhausschranke / Barrier of a public garage / Barrière de parking /  
Slagboom aan de parkeergarage / Barrera del aparcamiento /  
Barreiras do silo-auto

44

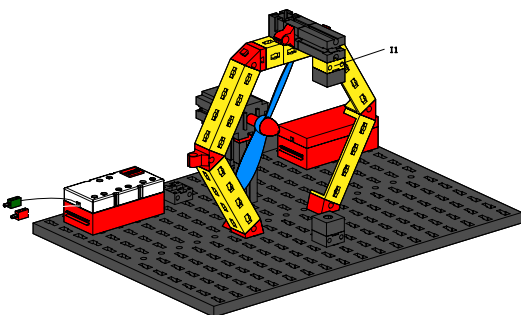

Händetrockner / Hand dryer / Sèche-mains /  
Handendroger / Secamanos / Secador de mãos

31

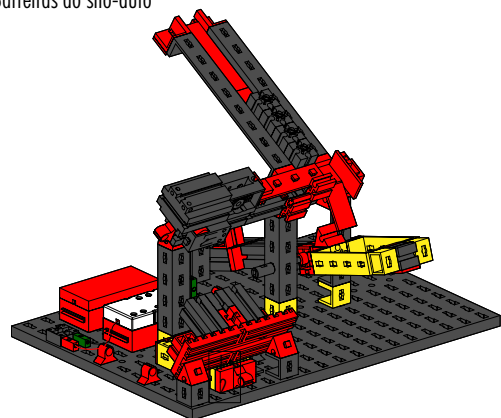

Bausteinspender / Brick dispenser / Distributeur d'éléments de  
construction / Bouwsteenautomaat / Dispensador de elementos /  
Distribuidor do componente

48

**Einzelteilübersicht**  
**Spare parts list**  
**Liste des pièces détachées**

**Onderdelenoverzicht**  
**Lista da piezas**  
**Resumo de peça individual**

 60°	31 010 4 x		31 982 4 x	 90	35 066 1 x		36 559 1 x		37 858 1 x
 30°	31 011 3 x		32 064 4 x		35 073 3 x		36 819 1 x		37 869 2 x
	31 016 1 x		32 233 1 x		35 076 3 x	 45	36 913 4 x		37 875 1 x
	31 021 1 x		32 263 1 x		35 079 1 x		36 920 4 x		38 216 4 x
 50	31 033 1 x		32 293 1 x		35 084 1 x		36 921 4 x		38 240 4 x
	31 058 3 x		32 330 2 x	 75	35 087 1 x		36 950 4 x		38 241 4 x
 15	31 060 5 x		32 850 1 x		35 969 8 x		37 034 1 x		38 242 1 x
 30	31 061 2 x		32 859 2 x		36 119 1 x		37 237 4 x		38 245 2 x
	31 063 1 x		32 870 2 x		36 120 1 x		37 238 2 x		38 246 2 x
	31 078 1 x		32 879 11 x		36 134 1 x		37 272 1 x		38 423 4 x
	31 336 22 x		32 881 10 x		36 293 3 x		37 351 3 x		38 428 5 x
	31 337 22 x		32 882 4 x		36 297 4 x		37 468 4 x		38 464 4 x
	31 360 1 x		32 958 1 x		36 299 2 x		37 636 1 x	 90	38 531 2 x
	31 426 2 x		32 985 1 x	 4	36 323 11 x		37 679 4 x		108 227 1 x
	31 436 3 x		35 031 3 x		36 334 2 x		37 681 1 x		108278 1 x
	31 848 2 x		35 049 2 x		36 443 1 x		37 727 4 x		
	31 915 1 x		35 053 5 x		36 532 2 x		37 783 3 x		