

Inhalt
Contents
Contenu

Inhoud
Contenido
Conteúdo

Einzelteilübersicht / Spare parts list / Liste des pièces détachées / Onderdelenoverzicht / Lista da piezas / Resumo de peça individual

1

Montagehilfen und Hinweise / Assembly aids and instructions / Aides de montage et instructions /
Montagehulpmiddelen en aanwijzingen / Ayudas de montaje e instrucciones / Montagens e indicações

3

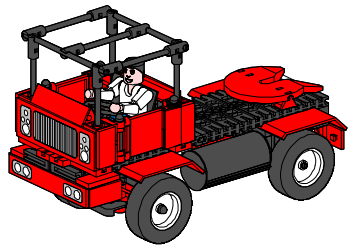

LKW-Zugmaschine / Truck traction vehicle /
Tracteur routier / Trekker /
Tractor de camión / Camião tractor

4

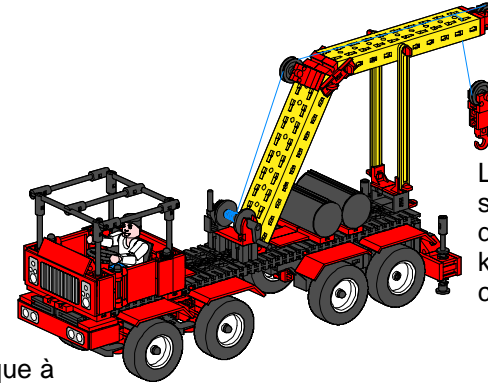

LKW mit Bergekran / Truck with
salvage crane / Camion avec grue
dépanneuse lourde / Vrachtwagen met
kraan / Grúa de salvamento / Camião
com guindaste de remoção

36

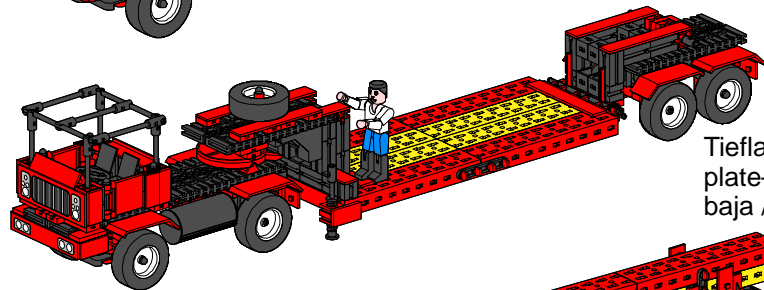

Tieflader / Low-bed truck / Semi-remorque à
plate-forme surbaissée / Dieplader / Plataforma
baja / Veículo de plataforma rebaixada

14

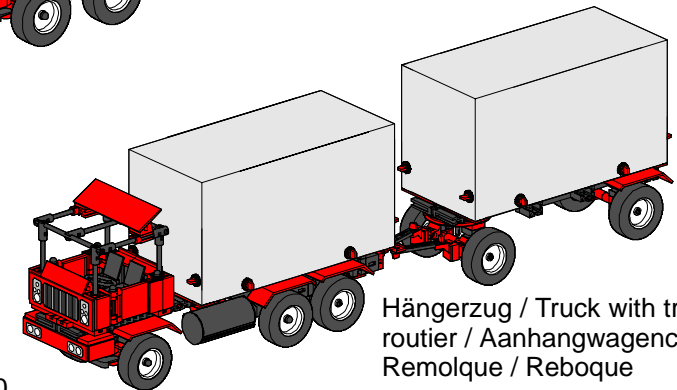

Hängerzug / Truck with trailer / Train
routier / Aanhangwagencombinatie /
Remorque / Reboque

47

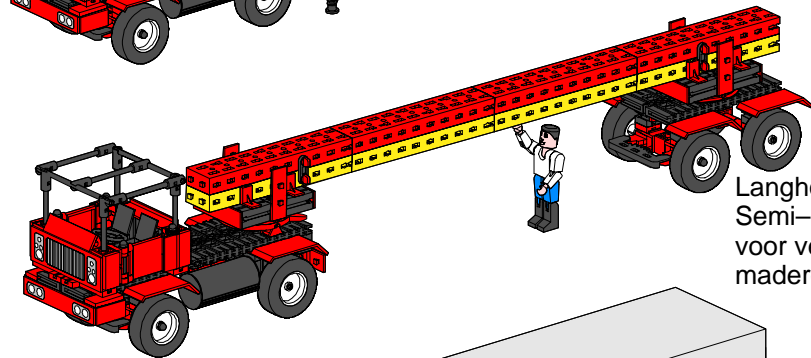

Langholztransporter / Timber truck /
Semi-remorque à long bois / Vrachtwagen
voor vervoer van lang hout / Transportador de
maderos largos / Transportador para toras

20

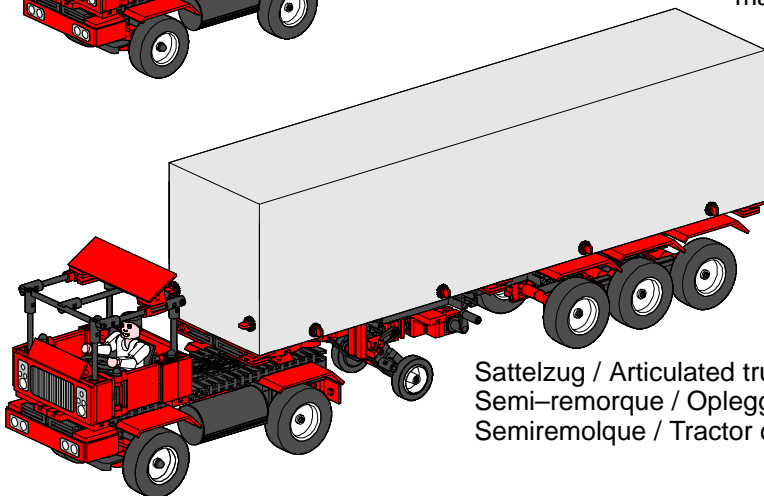

Sattelzug / Articulated truck /
Semi-remorque / Opleggercombinatie /
Semiremolque / Tractor de semi-reboque

25

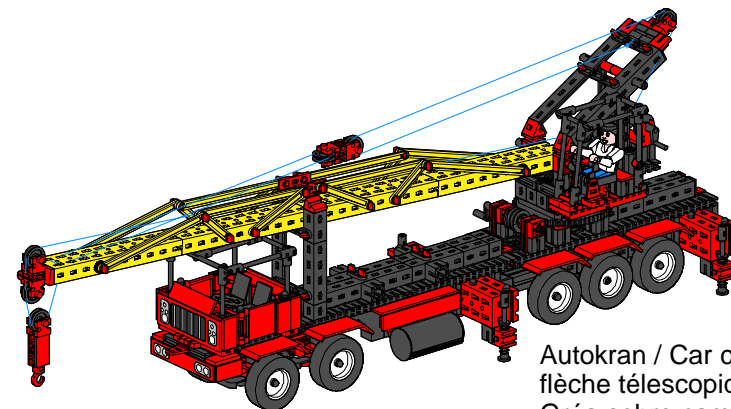









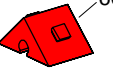
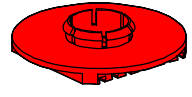



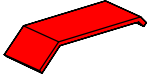

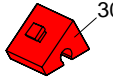





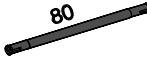
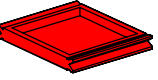

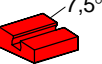
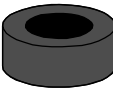





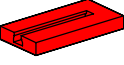
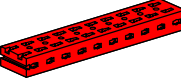





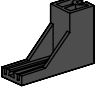
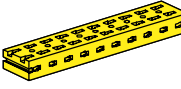

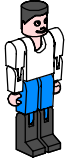

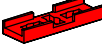
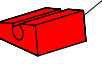

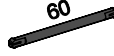
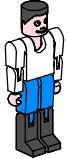

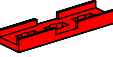







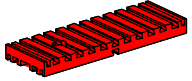



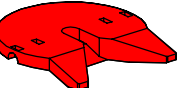





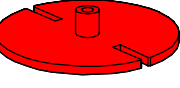

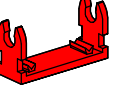
Autokran / Car crane / Grue mobile à
flèche télescopique / Kraanwagen /
Grúa sobre camión / Carro-grua

63

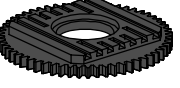
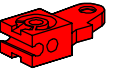

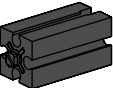
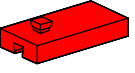







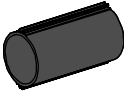
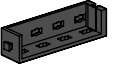



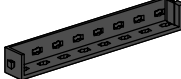



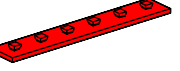

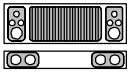





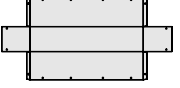





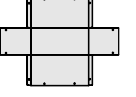



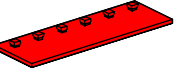
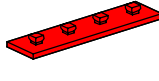

Einzelteilübersicht
Spare parts list
Liste des pièces détachées

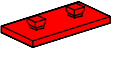
Onderdelenoverzicht
Lista da piezas
Resumo de peça individual

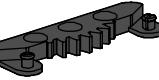
| | | | | | | | | | | | | | |
|--|-------|---|-------|---|-------|---|-------|---|-------|--|-------|--|-------|
|  60° | 31010 |  | 31391 |  | 31848 |  | 31999 |  | 32881 |  | 35050 |  | 35129 |
|  30° | 31011 |  | 31422 |  | 31888 |  | 32064 |  | 32882 |  | 35061 |  80 | 35405 |
|  | 31013 |  | 31426 |  | 31894 |  7,5° | 32071 |  | 32913 |  | 35062 |  98 | 35414 |
|  | 31019 |  | 31436 |  | 31915 |  | 32330 |  | 32968 |  30 | 35063 |  | 35797 |
|  200 cm | 31027 |  | 31597 |  | 31916 |  | 32615 |  | 32974 |  45 | 35064 |  | 35806 |
|  | 31058 |  | 31667 |  15° | 31981 |  | 32850 |  | 34994 |  60 | 35065 |  | 35973 |
|  15 | 31060 |  | 31668 |  | 31982 |  | 32852 |  | 34995 |  | 35067 |  | 35977 |
|  30 | 31061 |  | 31674 |  | 31983 |  | 32859 |  | 35031 |  | 35072 |  | 35977 |
|  | 31263 |  | 31690 |  | 31994 |  120 cm | 32869 |  | 35033 |  | 35073 |  | 35980 |
|  | 31264 |  | 31766 |  | 31997 |  | 32870 |  60 cm | 35039 |  75 | 35087 |  | 35998 |
|  | 31390 |  | 31843 |  | 31998 |  | 32879 |  | 35049 |  | 35088 |  | 36132 |

Einzelteilübersicht
Spare parts list
Liste des pièces détachées

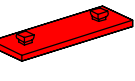
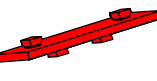
Onderdelenoverzicht
Lista da piezas
Resumo de peça individual

| | | | | | | | | | | | | | |
|--|--------------|--|--------------|--|--------------|--|--------------|--|--------------|--|--------------|---|--------------|
|  | 36227 26x |  | 36702 2x |  | 36921 12x |  | 37468 16x |  | 38244 4x |  | 38415 2x |  | 78727 10x |
|  | 36293 4x |  | 36703 4x |  | 36922 6x |  | 37636 9x |  | 38245 13x |  | 38423 26x |  | 104446 1x |
|  | 36323 24x |  | 36819 3x |  | 36923 2x |  | 37679 5x |  | 38246 10x |  | 38428 10x |  | 104447 1x |
|  | 36324 16x |  | 36912 2x |  | 36950 20x |  | 38225 1x |  | 38249 5x |  | 38446 2x |  | 104448 2x |
|  | 36326 4x |  | 36913 5x |  | 37232 2x |  | 38240 7x |  | 38251 2x |  | 38464 6x | | |
|  | 36334 18x |  | 36914 6x |  | 37237 47x |  | 38241 10x |  | 38253 3x |  | 38472 2x | | |
|  | 36335 8x |  | 36920 22x |  | 37238 8x |  | 38242 2x |  | 38277 8x |  | 38542 4x | | |

- Alle Einzelteile, insbesondere bewegliche Teile sind falls notwendig zu warten und zu reinigen.
- All components, especially moving parts, should be maintained and cleaned as necessary.
- Toutes les pièces détachées et en particulier les pièces mobiles, sont, si nécessaire, à entretenir et à nettoyer.

- Alle onderdelen, vooral de bewegende delen, kunnen, indien noodzakelijk, onderhouden en gereinigd worden.
- Es necesario limpiar y mantener en buen estado todas las diferentes piezas – especialmente las piezas móviles.
- Caso necessário, todas as peças individuais, especialmente peças móveis, tem que ser submetidas à manutenção e ser limpadas.

Montagehilfen und Hinweise
 Assembly aids and instructions
 Aides de montage et instructions

Montagehulpmiddelen en aanwijzingen
 Ayudas de montaje e instrucciones
 Montagens e indicações

