

Inhalt
Contents
Contenu

Inhoud
Contenido
Conteúdo

Contenuto
Содержание
目录

Einzelteilübersicht / Spare parts list / Liste des pièces détachées / Onderdelenoverzicht / Lista da piezas / Resumo de peça individual /
Singoli componenti / Отдельные детали / 零件概览 1

Montagetipps / Tips for assembly / Tuyaux pour le montage / Montagetips / Consejos para el montaje / "Dicas" para montagem /
Consigli per il montaggio / Советы по сборке / 装配建议 2

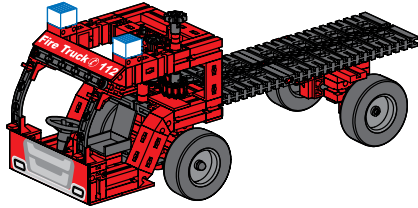

Basismodell 1 / Basic model 1 / Modèle de base 1 / Basismodel 1 / Modelo básico 1 /
Modelo básico 1 / Modello base 1 / Базовая модель 1 / 基本模型1 4

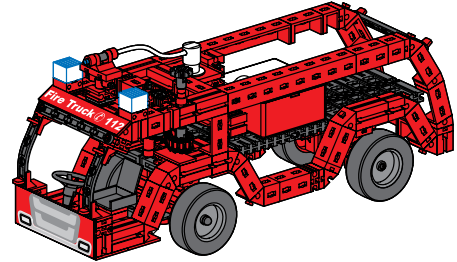

Flughafenfeuerwehr / Airport fire truck / Voiture de sapeurs-pompiers d'aéroport /
Luchthavenbrandweer / Bomberos de aeropuerto / Corpo de bombeiros de aeroporto / Vigili
del fuoco aeroportuali / Пожарная аэродромная машина / 机场用消防车 .. 12

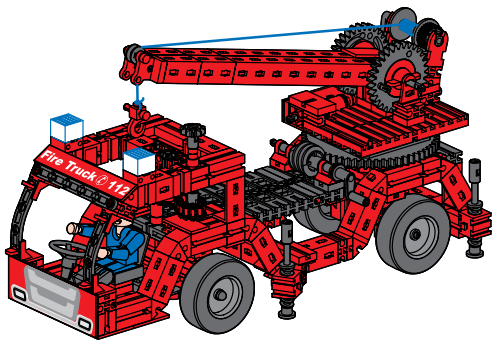

Feuerwehrkran / Fire fighting crane / Grue de secours routiers / Brandweerkraan /
Grúa de bomberos / Guincho de bombeiros / Gru vigili del fuoco / Пожарный кран /
消防用起重機 16

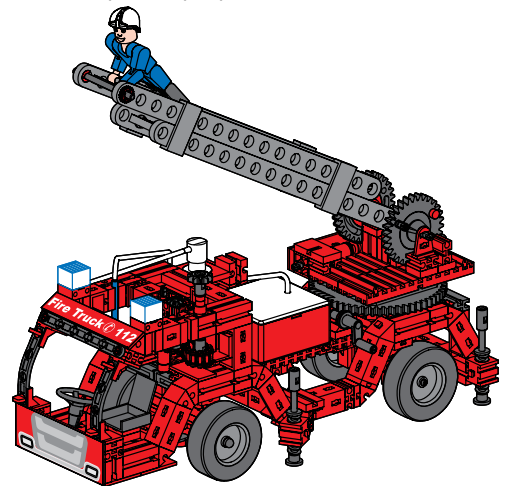

Fire Truck / Voiture de premiers secours avec grande échelle / Brandweerauto /
Camión de bomberos / Caminhão de bombeiros / Veicolo dei pompieri /
Пожарная машина / 消防车 22

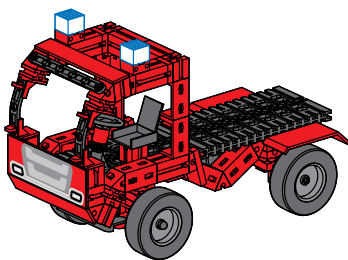

Basismodell 2 / Basic model 2 / Modèle de base 2 / Basismodel 2 / Modelo básico 2 /
Modelo básico 2 / Modello base 2 / Базовая модель 2 / 基本模型2 29

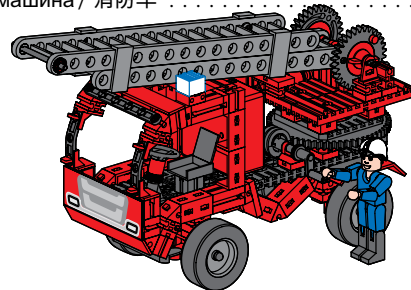

Drehleiterfahrzeug / Turntable ladder vehicle / Echelle pivotante automatique /
Voertuig met ladder / Vehículo con escalera giratoria / Veículo de escada rotativa /
Veicolo con scala girevole / Автомобиль с поворотной лестницей /
带旋转梯子的消防用车 36

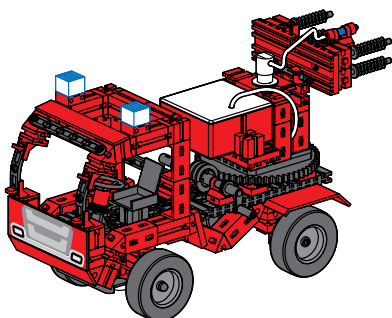

Powerlöscher / Multiple water canon fire truck / Voiture d'extinction haute puissance /
Power-blusser / Extintor de potencia / Extintor potente / Estintore Power /
Автомобиль для тушения электрических установок / 高功率灭火车 . 41

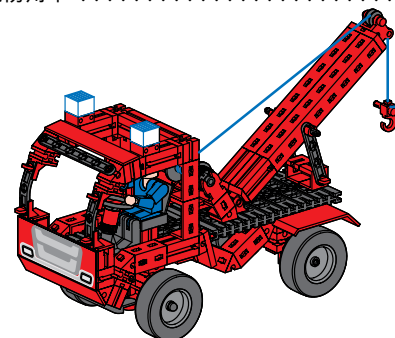











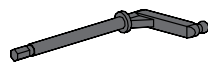

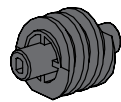

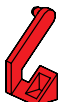
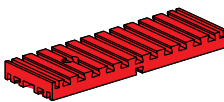







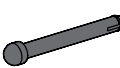
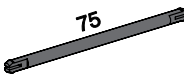
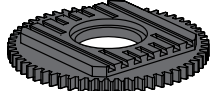

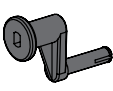
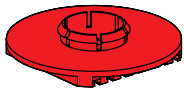

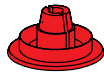





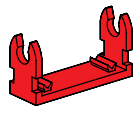
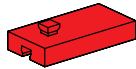

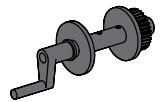
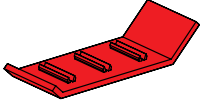



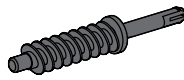

Abschleppwagen / Tow truck / DépanneuseKraanwagen / Coche-grúa / Carro reboque /
Carro attrezzí / Автомобиль-эвакуатор / 牵引车 45

Einzelteilübersicht
Spare parts list
Liste des pièces détachées

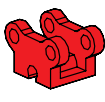
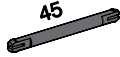
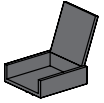
Onderdelenoverzicht
Lista da piezas
Resumo de peça individual



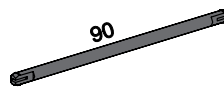









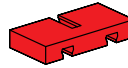

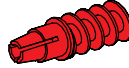
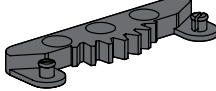
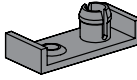

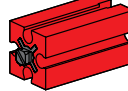





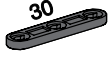
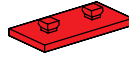
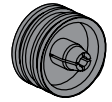

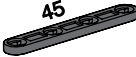
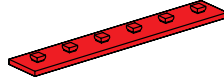



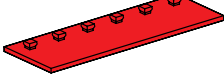
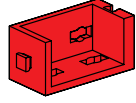
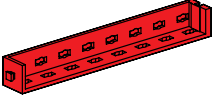
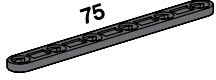

Singoli componenti
Отдельные детали
零件概览

	31 010 16 x		31 848 2 x		32 853 1 x		35 067 1 x
	31 011 8 x		31 888 2 x				35 072 1 x
	31 058 2 x		31 894 1 x		32 859 2 x		35 073 7 x
	31 060 3 x		31 915 2 x		32 869 1 x		35 077 2 x
	31 330 2 x		31 916 1 x		32 870 2 x		35 087 1 x
	31 390 1 x		31 981 4 x		32 913 4 x		35 088 2 x
	31 391 1 x		31 982 37 x		35 031 2 x		35 129 2 x
	31 426 2 x		31 983 1 x		35 033 2 x		35 414 1 x
	31 436 6 x		31 997 1 x		35 049 6 x		35 945 4 x
	31 597 5 x		31 998 1 x		35 050 2 x		35 973 4 x
	31 632 1 x		32 064 7 x		35 061 1 x		35 977 4 x
	31 674 4 x		32 071 2 x		35 063 4 x		35 980 4 x
	31 690 2 x		32 085 1 x		35 064 1 x		35 998 2 x
	31 766 1 x		32 851 1 x		35 065 2 x		36 132 4 x
	31 843 2 x		32 852 1 x		35 066 1 x		36 248 26 x

Einzelteilübersicht
Spare parts list
Liste des pièces détachées

Onderdelenoverzicht
Lista da piezas
Resumo de peça individual

Singoli componenti
Отдельные детали
零件概览

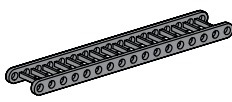
	36 264 2 x		37 679 8 x		38 428 5 x		130 961 1 x
	36 323 8 x		37 858 1 x		38 472 1 x		130 962 4 x
	36 334 3 x		38 225 1 x		116 251 11 x		130 966 1 x
	36 819 6 x		38 240 1 x		116 252 20 x		130 990 1 x
	36 912 2 x		38 241 7 x		116 913 4 x		131 998 1 x
	36 913 2 x		38 245 3 x		127 471 9 x		132 221 1 x
	36 914 1 x		38 251 3 x		127 472 22 x		132 223 2 x
	36 923 2 x		38 253 1 x		130 593 1 x		132 226 2 x
	37 237 26 x		38 258 1 x		130 770 1 x		132 228 1 x
	37 238 15 x		38 416 1 x		130 772 1 x		
	37 468 24 x		38 423 6 x		130 925 2 x		

- Alle Einzelteile, insbesondere bewegliche Teile sind falls notwendig zu warten und zu reinigen.
- All components, especially moving parts, should be maintained and cleaned as necessary.
- Toutes les pièces détachées et en particulier les pièces mobiles, sont, si nécessaire, à entretenir et à nettoyer.
- Alle onderdelen, vooral de bewegende delen, kunnen, indien noodzakelijk, onderhouden en gereinigd worden.

- Achtung
Verletzungsgefahr an Bauteilen mit funktionsbedingten scharfen Kanten und Spitzen!
- Caution
Be careful not to hurt yourself on components with sharp or pointed edges!
- Attention
Risque de blessure sur les éléments comportant des arêtes et o pointes vives indispensables au bon fonctionnement!
- Let op
U kunt zich bezeren aan bouwstenen met sherpe randen of punten!

- Es necesario limpiar y mantener en buen estado todas las diferentes piezas - especialmente las piezas móviles.
- Caso necessário, todas as peças individuais, especialmente peças móveis, tem que ser submetidas à manutenção e ser limpadas.
- Se necessario, tutti i singoli componenti, soprattutto le parti mobili, si devono eventualmente sottoporre a manutenzione e pulizia.
- Все детали, особенно подвижные, требуют ухода и чистки.
- 必要时应保养和清洁所有零件, 尤指运动部件。

- Attenzione
Esiste il pericolo di lesione con i pezzi di costruzione che hanno bordi e punte spigolosi necessari per la funzionalità del pezzo!
- Atenção
Perigo de ferimentos em peças componentes com cantos vivos e pontas obrigatórias para o funcionamento !
- Attention
Pericolo di lesioni dovute a componenti con spigoli vivi e punte per motivi funzionali!
- Будьте осторожны
Об острые края деталей и и наконечники можно обрезать!
- 注意
因功能需要而带有锋利的棱边和尖角的部件可能会带来受伤危险!